







COASSIALE VENTILATO INOX INTERNO



ELEMENTO LINEARE H=1000

ZINCATO	INOX	RAME		CODICE	Øi - Øe	PREZZO
			ZINCATO	TC050Z-08	80/130	€ 60,00
			TC050Z-10	100/150	€ 70,00	
			TC050Z-13	130/200	€ 80,00	
			TC050Z-16	160/230	€ 90,00	
			INOX	TC050S-08	80/130	€ 70,00
			TC050S-10	100/150	€ 90,00	
			TC050S-13	130/200	€ 110,00	
			TC050S-16	160/230	€ 130,00	
			RAME	TC050R-08	80/130	€ 100,00
			TC050R-10	100/150	€ 115,00	
			TC050R-13	130/200	€ 150,00	
			TC050R-16	160/230	€ 180,00	



ELEMENTO LINEARE H=500

ZINCATO	INOX	RAME		CODICE	Øi - Øe	PREZZO
			ZINCATO	TC030Z-08	80/130	€ 40,00
			TC030Z-10	100/150	€ 45,00	
			TC030Z-13	130/200	€ 55,00	
			TC030Z-16	160/230	€ 65,00	
			INOX	TC030S-08	80/130	€ 50,00
			TC030S-10	100/150	€ 60,00	
			TC030S-13	130/200	€ 75,00	
			TC030S-16	160/230	€ 85,00	
			RAME	TC030R-08	80/130	€ 70,00
			TC030R-10	100/150	€ 80,00	
			TC030R-13	130/200	€ 100,00	
			TC030R-16	160/230	€ 110,00	

ELEMENTO LINEARE H=250



ZINCATO	INOX	RAME		CODICE	Øi - Øe	PREZZO
			ZINCATO	TC010Z-08	80/130	€ 30,00
			TC010Z-10	100/150	€ 35,00	
			TC010Z-13	130/200	€ 45,00	
			TC010Z-16	160/230	€ 50,00	
			INOX	TC010S-08	80/130	€ 40,00
			TC010S-10	100/150	€ 45,00	
			TC010S-13	130/200	€ 55,00	
			TC010S-16	160/230	€ 60,00	
			RAME	TC010R-08	80/130	€ 55,00
			TC010R-10	100/150	€ 60,00	
			TC010R-13	130/200	€ 70,00	
			TC010R-16	160/230	€ 80,00	

CURVA A 45°



INOX	RAME		CODICE	Øi - Øe	PREZZO	
						
		INOX	TC230S-08	80/130	€ 48,00	
		TC230S-10	100/150	€ 54,00		
		TC230S-13	130/200	€ 62,00		
		TC230S-16	160/230	€ 74,00		
		RAME	TC230R-08	80/130	€ 65,00	
		TC230R-10	100/150	€ 70,00		
		TC230R-13	130/200	€ 80,00		
		TC230R-16	160/230	€ 95,00		

COASSIALE VENTILATO INOX INTERNO



RACCORDO T 90° "ESPULSIONE FUMI" CON USCITA RIDOTTA A Ø80 MASCHIO

INOX	RAME		CODICE	Øi - Øe	PREZZO
		INOX	TC310S-08	80/130	€ 80,00
			TC310S-10	100/150	€ 95,00
			TC310S-13	130/200	€ 110,00
			TC310S-16	160/230	€ 130,00
			TC310R-08	80/130	€ 105,00
		RAME	TC310R-10	100/150	€ 125,00
			TC310R-13	130/200	€ 145,00
			TC310R-16	160/230	€ 170,00



RACCORDO T 90° "ADDUZIONE ARIA COMBURENTE" CON USCITA RIDOTTA A Ø80 MASCHIO

INOX	RAME		CODICE	Øi - Øe	PREZZO
		INOX	TC330S-08	80/130	€ 80,00
			TC330S-10	100/150	€ 95,00
			TC330S-13	130/200	€ 110,00
			TC330S-16	160/230	€ 130,00
			TC330R-08	80/130	€ 105,00
		RAME	TC330R-10	100/150	€ 125,00
			TC330R-13	130/200	€ 145,00
			TC330R-16	160/230	€ 170,00

RACCORDO T 90° "ESPULSIONE FUMI" CON USCITA RIDOTTA A Ø80 MASCHIO+ARIA COMBURENTE DESTRA



INOX	RAME		CODICE	Øi - Øe	PREZZO
		INOX	TC320S-08	80/130	€ 140,00
			TC320S-10	100/150	€ 150,00
			TC320S-13	130/200	€ 170,00
			TC320S-16	160/230	€ 190,00
			TC320R-08	80/130	€ 180,00
		RAME	TC320R-10	100/150	€ 195,00
			TC320R-13	130/200	€ 220,00
			TC320R-16	160/230	€ 250,00

RACCORDO T 90° "ESPULSIONE FUMI" CON USCITA RIDOTTA A Ø80 MASCHIO+ARIA COMBURENTE SINISTRA



INOX	RAME		CODICE	Øi - Øe	PREZZO
		INOX	TC325S-08	80/130	€ 140,00
			TC325S-10	100/150	€ 150,00
			TC325S-13	130/200	€ 170,00
			TC325S-16	160/230	€ 190,00
			TC325R-08	80/130	€ 180,00
		RAME	TC325R-10	100/150	€ 195,00
			TC325R-13	130/200	€ 220,00
			TC325R-16	160/230	€ 250,00

COASSIALE VENTILATO INOX INTERNO



RACCORDO A T 90° "VENTILAZIONE"

INOX	RAME		CODICE	Øi - Øe	PREZZO
		INOX	TC340S-08	80/130	€ 80,00
			TC340S-10	100/150	€ 95,00
			TC340S-13	130/200	€ 110,00
			TC340S-16	160/230	€ 130,00
		RAME	TC340R-08	80/130	€ 105,00
			TC340R-10	100/150	€ 125,00
			TC340R-13	130/200	€ 145,00
			TC340R-16	160/230	€ 170,00



GRIGLIA DI PROTEZIONE PER T 90° DI VENTILAZIONE

INOX	RAME		CODICE	Øi - Øe	PREZZO
		INOX	TC976S-13	130/170	€ 30,00
			TC976S-16	160/200	€ 40,00
		RAME	TC976R-13	130/170	€ 45,00
			TC976R-16	160/200	€ 60,00

RACCORDO A T 90° CON USCITA COASSIALE 80/130 PER PROLUNGAMENTO ORIZZONTALE



INOX	RAME		CODICE	Øi - Øe	PREZZO
		INOX	TC350S-08	80/130	€ 80,00
			TC350S-10	100/150	€ 95,00
			TC350S-13	130/200	€ 110,00
			TC350S-16	160/230	€ 130,00
		RAME	TC350R-08	80/130	€ 105,00
			TC350R-10	100/150	€ 125,00
			TC350R-13	130/200	€ 145,00
			TC350R-16	160/230	€ 170,00

RACCORDO A T 90° DI ISPEZIONE CON TAPPO A TENUTA



INOX	RAME		CODICE	Øi - Øe	PREZZO
		INOX	TC410S-08	80/130	€ 100,00
			TC410S-10	100/150	€ 110,00
			TC410S-13	130/200	€ 130,00
			TC410S-16	160/230	€ 160,00
		RAME	TC410R-08	80/130	€ 130,00
			TC410R-10	100/150	€ 135,00
			TC410R-13	130/200	€ 165,00
			TC410R-16	160/230	€ 210,00

COASSIALE VENTILATO INOX INTERNO



AUMENTO DI SEZIONE

INOX	RAME		CODICE	Øi - Øe	PREZZO
		INOX	TC660S-08	80/130× 100/150	€ 70,00
			TC660S-10	100/150× 130/200	€ 80,00
			TC660S-13	130/200× 160/230	€ 95,00
		RAME	TC660R-08	80/130× 100/150	€ 90,00
			TC660R-10	100/150× 130/200	€ 105,00
			TC660R-13	130/200× 160/230	€ 125,00

DOPPIO TAPPO DI SCARICO CONDENSA

INOX	RAME		CODICE	Øi - Øe	PREZZO
		INOX	TC710S-08	80/130	€ 55,00
			TC710S-10	100/150	€ 60,00
			TC710S-13	130/200	€ 80,00
			TC710S-16	160/230	€ 120,00
		RAME	TC710R-08	80/130	€ 75,00
			TC710R-10	100/150	€ 85,00
			TC710R-13	130/200	€ 110,00
			TC710R-16	160/230	€ 165,00

PIASTRA DI SUPPORTO INTERMEDIA



INOX	RAME		CODICE	Øi - Øe	PREZZO
		INOX	TC510S-08	80/130	€ 70,00
			TC510S-10	100/150	€ 80,00
			TC510S-13	130/200	€ 100,00
			TC510S-16	160/230	€ 120,00
		RAME	TC510R-08	80/130	€ 90,00
			TC510R-10	100/150	€ 105,00
			TC510R-13	130/200	€ 130,00
			TC510R-16	160/230	€ 150,00

COPPIA ALETTE PER PIASTRA INTERMEDIA



INOX	RAME		CODICE	DIM.	PREZZO
		INOX	TD520S-08	230×230	€ 40,00
			TD520S-10	250×250	€ 44,00
			TD520S-15	300×300	€ 52,00
			TD520S-18	330×330	€ 68,00
		RAME	TD520R-08	230×230	€ 50,00
			TD520R-10	250×250	€ 55,00
			TD520R-15	300×300	€ 65,00
			TD520R-18	330×330	€ 85,00

COASSIALE VENTILATO INOX INTERNO



STAFFA DI FISSAGGIO A PARETE FISSA STACCO DA MURO 50 mm

INOX	RAME		CODICE	∅	PREZZO
		INOX	TD550S-08	130	€ 18,00
			TD550S-10	150	€ 20,00
			TD550S-15	200	€ 25,00
			TD550S-18	230	€ 28,00
		RAME	TD550R-08	130	€ 28,00
			TD550R-10	150	€ 31,00
			TD550R-15	200	€ 38,00
			TD550R-18	230	€ 41,00



STAFFA DI FISSAGGIO A PARETE STACCO DA MURO REGOLABILE 50/80 mm

INOX	RAME		CODICE	∅	PREZZO
		INOX	TD555S-08	130	€ 20,00
			TD555S-10	150	€ 22,00
			TD555S-15	200	€ 27,00
			TD555S-18	230	€ 30,00
		RAME	TD555R-08	130	€ 35,00
			TD555R-10	150	€ 40,00
			TD555R-15	200	€ 52,00
			TD555R-18	230	€ 57,00

COLLARE DI FISSAGGIO CON TASSELLO



INOX	RAME		CODICE	∅	PREZZO
		INOX	TC590S-08	130	€ 9,50
			TC590S-10	150	€ 10,50
			TC590S-13	200	€ 12,00
			TC590S-16	230	€ 14,00
		RAME	TC590R-08	130	€ 19,00
			TC590R-10	150	€ 22,00
			TC590R-13	200	€ 24,00
			TC590R-16	230	€ 28,00

FASCETTA DI CHIUSURA



INOX	RAME		CODICE	∅	PREZZO
		INOX	TD960S-08	130	€ 7,00
			TD960S-10	150	€ 7,30
			TD960S-15	200	€ 7,70
			TD960S-18	230	€ 8,00
		RAME	TD960R-08	130	€ 9,00
			TD960R-10	150	€ 9,50
			TD960R-15	200	€ 10,50
			TD960R-18	230	€ 11,00

COASSIALE VENTILATO INOX INTERNO



TORRETTA ANTIVENTO

INOX	RAME		CODICE	Øi - Øe	PREZZO
		INOX	TC810S-08	80/130	€ 100,00
			TC810S-10	100/150	€ 110,00
			TC810S-13	130/200	€ 130,00
			TC810S-16	160/230	€ 160,00
		RAME	TC810R-08	80/130	€ 130,00
			TC810R-10	100/150	€ 140,00
			TC810R-13	130/200	€ 160,00
			TC810R-16	160/230	€ 200,00



TORRETTA TRONCO DI CONO

INOX	RAME		CODICE	Øi - Øe	PREZZO
		INOX	TC830S-08	80/130	€ 95,00
			TC830S-10	100/150	€ 100,00
			TC830S-13	130/200	€ 120,00
			TC830S-16	160/230	€ 150,00
		RAME	TC830R-08	80/130	€ 125,00
			TC830R-10	100/150	€ 130,00
			TC830R-13	130/200	€ 160,00
			TC830R-16	160/230	€ 180,00

TORRETTA A ELEMENTI

INOX	RAME		CODICE	Øi - Øe	PREZZO
		INOX	TC850S-08	80/130	€ 140,00
			TC850S-10	100/150	€ 160,00
			TC850S-13	130/200	€ 180,00
			TC850S-16	160/230	€ 200,00
		RAME	TC850R-08	80/130	€ 180,00
			TC850R-10	100/150	€ 200,00
			TC850R-13	130/200	€ 220,00
			TC850R-16	160/230	€ 240,00

TERMINALE DI SCARICO ORIZZONTALE

INOX	RAME		CODICE	Øi - Øe	PREZZO
		INOX	TC870S-08	80/130	€ 80,00
			TC870S-10	100/150	€ 95,00
			TC870S-13	130/200	€ 130,00
			TC870S-16	160/230	€ 150,00
		RAME	TC870R-08	80/130	€ 105,00
			TC870R-10	100/150	€ 125,00
			TC870R-13	130/200	€ 165,00
			TC870R-16	160/230	€ 200,00

COASSIALE VENTILATO INOX INTERNO



SCOSSALINA PER FALDALE

INOX	RAME		CODICE	∅	PREZZO
		INOX	TD920S-08	130	€ 26,00
			TD920S-10	150	€ 31,00
			TD960S-15	200	€ 41,00
			TD960S-18	230	€ 45,00
			TD920R-08	130	€ 40,00
		RAME	TD920R-10	150	€ 44,00
			TD920R-15	200	€ 60,00
			TD920R-18	230	€ 74,00

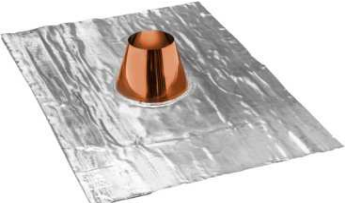

FALDALE PIANO CON BASE IN PIOMBO

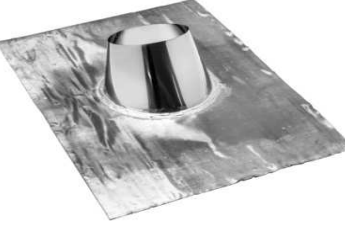
INOX	RAME		CODICE	∅	PREZZO
		INOX	TD930S-08	130	€ 125,00
			TD930S-10	150	€ 125,00
			TD930S-15	200	€ 145,00
			TD930S-18	230	€ 160,00
			TD930R-08	130	€ 130,00
		RAME	TD930R-10	150	€ 130,00
			TD930R-15	200	€ 155,00
			TD930R-18	230	€ 170,00

FALDALE INCLINATO CON BASE IN PIOMBO

INOX	RAME		CODICE	∅	PREZZO
		INOX	TD940S-08	130	€ 125,00
			TD940S-10	150	€ 125,00
			TD940S-15	200	€ 145,00
			TD940S-18	230	€ 160,00
			TD940R-08	130	€ 130,00
		RAME	TD940R-10	150	€ 130,00
			TD940R-15	200	€ 155,00
			TD940R-18	230	€ 170,00

COPPELLE ISOLANTI

LANA DI ROCCIA	POLIETILENE		CODICE	∅	PREZZO
		POLIETILENE	TC984-08	130	€ 15,00
			TC984-10	150	€ 17,00
			TC984-13	200	€ 20,00
			TC984-16	280	€ 25,00
		LANA	TC980-13	130	€ 18,00
			TC980-15	150	€ 20,00
			TC980-20	200	€ 25,50
			TC980-23	280	€ 31,00

